

# interface

ADVANCED FORCE MEASUREMENT



## WTS-BS-1

Handheld Display Unlimited Inputs

Issue: 15-181 Revision B

User Manual

[www.interfaceforce.com](http://www.interfaceforce.com)

<b>Introduction / Overview .....</b>	<b>2</b>
Quick Start .....	2
Connecting Power .....	2
WTS-BS-1 .....	<b>Error! Bookmark not defined.</b>
Acquisition Module .....	2
View readings .....	2
WTS-BS-1 Operation.....	3
Keys .....	3
Indicators.....	3
Errors .....	3
Special Modes .....	4
<b>Configuration.....</b>	<b>5</b>
Installation .....	5
Toolkit.....	5
Base Station .....	5
Requirements .....	5
Suggestions .....	5
Toolkit.....	6
Setup Base Station Communications .....	6
Home .....	7
Analyzer .....	8
Data Provider Monitor .....	9
Information .....	10
Display Format .....	11
Display Format Advanced Settings.....	12
Channel and Encryption .....	13
Save and Restore .....	14
Advanced Settings .....	15
<b>Installation.....</b>	<b>16</b>
Example Scenarios .....	16
Overview.....	17
Antenna Orientation .....	18
Battery .....	18
<b>Specifications .....</b>	<b>19</b>
General Radio.....	19
WTS-BS-1.....	<b>Error! Bookmark not defined.</b>
<b>Approvals .....</b>	<b>19</b>
CE .....	19
FCC.....	20
Industry Canada .....	20
<b>OEM / Reseller Marking and Documentation Requirements .....</b>	<b>20</b>
FCC.....	20
IC .....	21
CE .....	21
<b>Worldwide Regional Approvals.....</b>	<b>21</b>
Important Note .....	21
<b>Warranty .....</b>	<b>22</b>

## Introduction / Overview

All of the WTS devices contain a RAD24 2.4GHz radio telemetry module, including the WTS-BS-1. The WTS-BS-1 is a roaming handheld that can be used to view the reading supplied by an unlimited number of acquisition modules. All of the WTS devices have a unique identifier or Data Tag. This Data Tag is a 4 character hexadecimal number, C6E4 for example. The acquisition Data Tags or IDs do not need to be known beforehand to use the WTS-BS-1.

The handheld will automatically wake any device on the same channel and encryption key. An internal list is maintained of the top *n* number of acquisition modules ordered by signal level and a **Next** key on the handheld allows cycling through this list. The list size (*n*) is variable between 2 and 20 and this enables the viewing experience to be tailored to particular applications.

The acquisition modules are identified by their 4 character hexadecimal Data Tags and these may be set using the Toolkit.

When in communication with a particular acquisition module the LED on that module is activated. This provides visual feedback of the selected and currently viewed module. The LED output can also appear optionally on the digital output.

## Quick Start

This section will show you how to get the device pair working out of the box. You will require 2 X AA alkaline batteries for the handheld and a 3 Volt dc supply for the acquisition module which may also be a pair of AA batteries.

## Connecting Power

### WTS-BS-1

Remove the two screws on the rear battery compartment. Insert two alkaline AA batteries. Refit the battery compartment cover. The handheld device is now switched on so should be turned off until the acquisition module is ready. To turn off just hold down the power key until the display shows **BUSY** then release it.

### Acquisition Module

See the acquisition module manual.

## View readings

As long as the acquisition device is on the same channel as the handheld you will be able to view the reading once the handheld is turned on. The WTS modules are set to channel 1 by default.

If you need to change the channel of the acquisition module you will need to use the Toolkit software or see Pairing later in the manual.

Each time you press the Next key  the handheld will cycle to the next acquisition module in its list of detected modules. The Data Tag of the selected module will be displayed briefly before the reading is displayed.

To view the Data Tag of the currently viewed module press and hold the next key  for around a second and the Data Tag will be displayed and the reading will remain that of the current module without stepping on.

## WTS-BS-1 Operation

### Keys



Press and hold the power key for approximately 2 seconds then release the key. This will toggle between turning the handheld on and off.  
Can also be used, by giving a quick press, to reset the Auto-Sleep delay.

Selects the next module to view.  
Pressing and holding will display the currently viewed module Data Tag without moving to the next module.

### Indicators

#### SIG LOW

The radio signal from the acquisition module is low. The device is still functioning but the limit of the range may be near. Communications may start to deteriorate when this indicator is visible. Until ----- is displayed the communications is still OK and the display can be relied on for accuracy.  
**Note:** Even with a degraded signal the display value will always be correct.

#### BATT LOW

The batteries in the handheld are low and need to be replaced.

#### REMOTE ERROR

The acquisition module has an error that the handheld does not recognize.

#### REMOTE BATT LOW

The battery or supply to the acquisition module is low.

### Errors

Displayed on handheld LCD.

#### Error 1

The acquisition module has a strain gauge input and is in shunt cal mode. An external device has placed the acquisition module in Shunt Calibration mode so rather than display a misleading reading this error is displayed instead. Modules such as the WTS-AM-1 support this error type.

#### Error 2

Input integrity error. The acquisition module has found a problem with the input. There may be open or short circuits. Rather than display a misleading reading this error is displayed instead.  
Only certain acquisition modules support this error such as the WTS-AM-1.

#### Overload

A user settable value which when exceeded causes this message to be displayed.

## Special Modes

WTS-BS-1 label actually has 6 keys but only 2 are marked. The following modes require some of the unmarked keys. The picture to the right shows the position of the keys.



### Pair



The handheld has the ability to configure an acquisition module to match the handheld's own radio channel and encryption key settings. Ensure that the acquisition module is unpowered for at least 10 seconds. Locate the upper left key by feeling for a slight bump on the label.

Press and hold this key for 5 seconds until PAIRING appears on the LCD. Release the key and apply power to the acquisition module.

The amount of time you have to reapply power to the acquisition device can be set by **PairDuration** in the Toolkit when connected to the WTS-BS-1. This defaults to 5 seconds.

### System Zero



The handheld has the ability to perform a system zero on a remote acquisition module. This may be useful after installing new modules and enables system zero to be set without the need for a PC/laptop and Toolkit.

Set the handheld to view the desired acquisition module by using the Next key.

Locate the upper right key and lower right key by feeling for slight bumps on the label.

Press and hold these keys for around 8 seconds until ZERO appears on the LCD. Release the keys and the display should then show the zeroed reading.

This system zero is performed at the acquisition module and is stored through power cycling.

## Configuration

This section explains how to install software and connect the required devices together. Please note that you will need the Toolkit software and a USB WTS-BS base station to allow your computer to communicate with WTS telemetry devices.

## Installation

### Toolkit

To configure the devices we must use the **Toolkit** software application. This can be downloaded from our web site.

Install this on a PC or laptop.

Run setup.exe and follow the prompts to install the software.

### Base Station

If you have a USB version of the base station (WTS-BS-3, WTS-BS-4) then you just need to plug this into a USB socket on your PC.

### Requirements

The WTS-BS-1 requires version 1.05 or higher acquisition module.

The Sleep Delay of these modules needs to be set to a non-zero time if the modules are required to return to deep sleep when the WTS-BS-1 is turned off or taken out of range.

### Suggestions

Unless the acquisition modules are permanently powered their Sleep Delay setting should be set to a non-zero value so that the module returns to deep sleep when the handheld is turned off or goes out of range. It is suggested that this time is set to at least 3 times the interval between its data transmissions. i.e. The default rate of 333 ms (3Hz) so set the Sleep Delay to 5 seconds.

Most acquisition modules allow the LED state to be echoed to the digital output line which allows an external LED to be installed. This is useful when requiring visual feedback of the module the handheld is currently viewing.

The handheld displays the data at the rate that the acquisition module is configured to supply. The ideal rate is about 3 Hz which is the default but the handheld will operate quite happily with modules with a data delivery rate of down to around 1 every 30 seconds. Just remember to set the Timeout of the handheld to at least 3 times this period. (i.e. 91 seconds in the case of 30 second transmission interval).

NOTE: The handheld will wake **any** sleeping module if it is on the same channel and has the same encryption key.



## Toolkit

The Toolkit provides a means of simple configuration of the WTS-BS-1 handheld and associated acquisition module along with useful tools to aid integration. Calibration of the acquisition module is also provided.

Run the Toolkit software application.

PLEASE NOTE: Depending on which acquisition module is selected the screenshots may vary slightly. This will generally be in naming of units and device descriptions. The screenshots shown are those shown when a strain gauge acquisition module is connected.

## Setup Base Station Communications

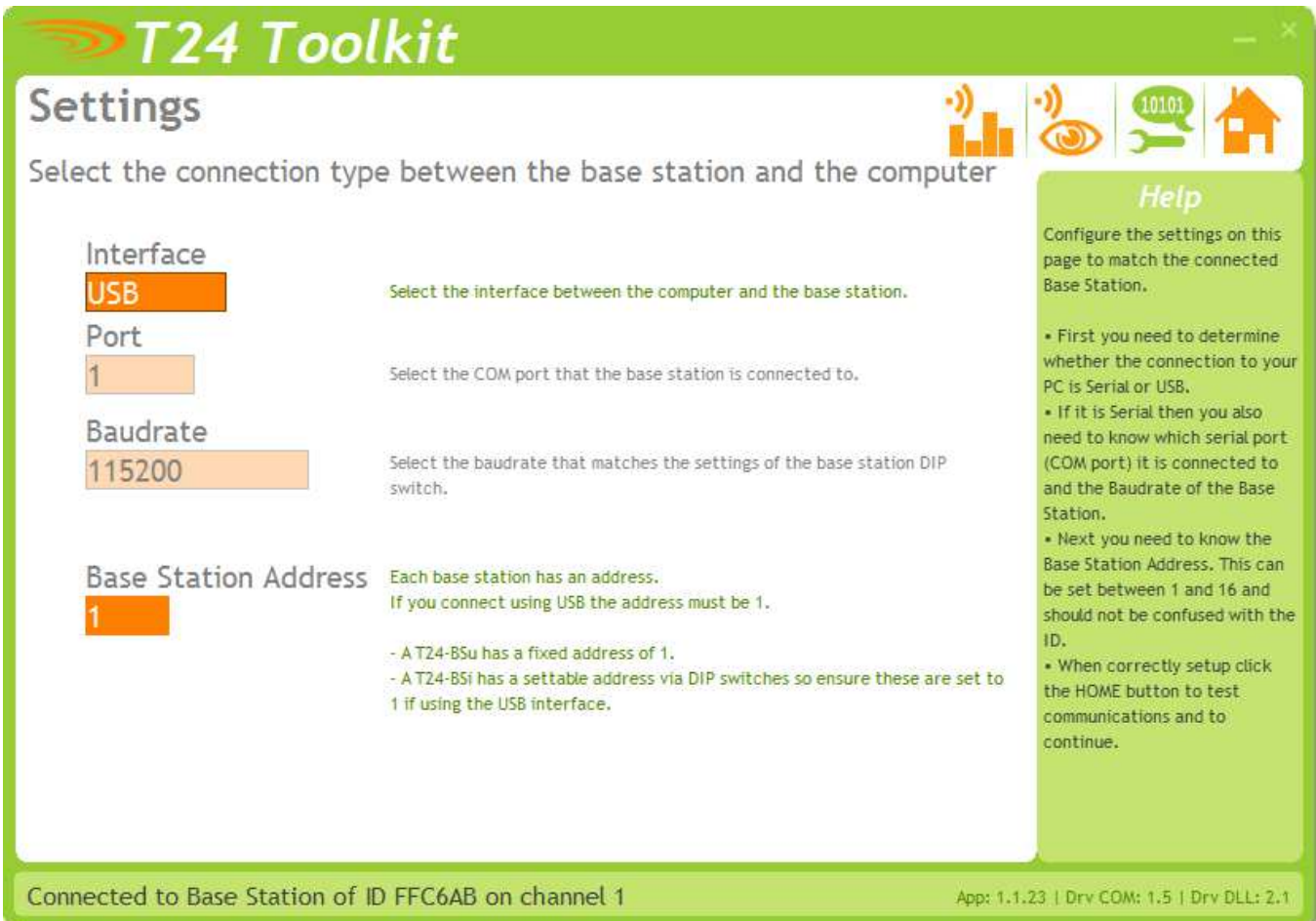

Select **USB** as the interface and select **1** as the Base Station Address. In the toolkit all items that can be changed by the user are colored orange.

To change a value just click on the relevant orange item. You will then be presented with a new dialog window allowing you to change the value. This may use a slider, text box or list to allow your new value to be entered.

Click the Home button to attempt communications with the base station. If no communications can be established the toolkit will remain on this page. You will need to check that the base station is powered and that it is connected to the converter correctly.

**T24 Toolkit** Data Provider Monitor

### Home

**Monitor or Log**  
You can view and log the data being transmitted from an acquisition device or view the spectrum analyser by clicking the icons above right. Pairing is NOT required to log data from your device.

**Configure your device**  
To configure your device we need to temporarily pair to it. When we pair from the Toolkit we configure the base station radio settings to match the remote device. To pair you must:

- Remove the power from your device.
- Initiate the pair by clicking the button below.
- Re-apply the power to the device.

When applying power be careful to do this cleanly because if the device is powered up with an intermittent connection it may reset during pairing and result in poor or no communications.

**Pair**

The device cannot be paired with as access to the power supply is either not possible or many devices share the same power supply. [Click Here](#) for advanced connection.

### Help

This Home page is where you begin your connection to your device. You must be able to access its power supply so you can remove and reapply it.

The device you want to connect to must be the only device you reapply power to.

When pairing to a device the base station settings are changed to match those of the remote device.

[To connect to the base station hold the Shift key while clicking the Pair button]

Connected to Base Station of ID FFC6AB on channel 1 App: 1.1.23 | Drv COM: 1.5 | Drv DLL: 2.1

We now have successful communications with the base station so we can now pair with our device or we can select the Spectrum Analyzer mode or Data Provider Monitor mode.

To connect to our device we will pair. This is achieved by power cycling the device. Pairing removes the need to know the radio settings of the device you are connecting to and also ensures that it is in a suitable state for configuration.

### Pairing Procedure

- Remove at least one battery from the handheld module.
- Click the Pair button on the toolkit.
- You now have 10 seconds to replace the handheld batteries.

If you connect successfully the toolkit will change to the Information page.  
If the pairing fails try again.

**NOTE: Pairing with the toolkit will not change the radio configuration settings of the connected device.**



## Analyzer

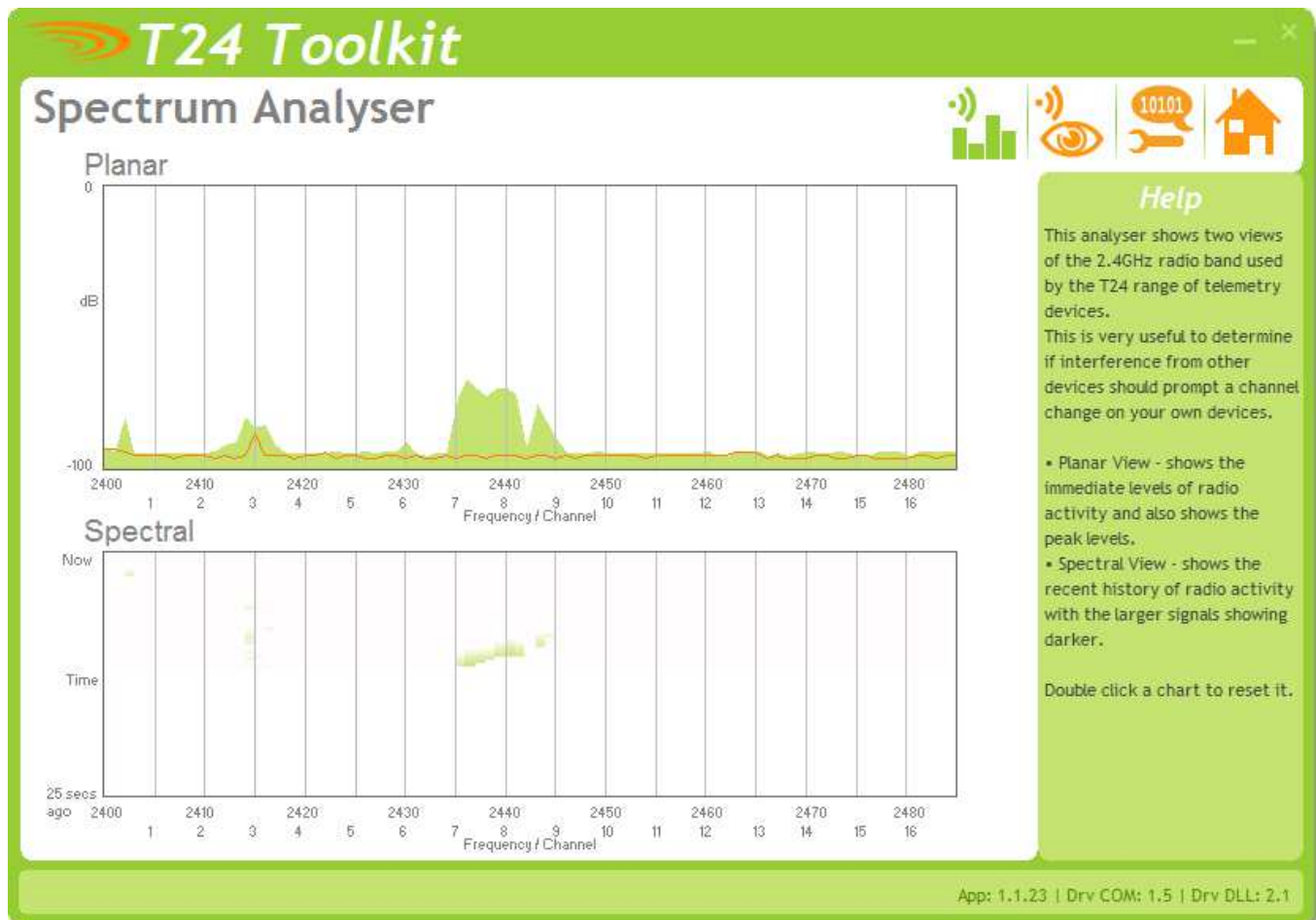

The analyzer page is provided as a tool and will not normally be needed unless you plan to change channels and want to find the best channel to select, or to diagnose poor communications issues.

This page shows the radio signal levels detected across all the channels available to the WTS series of devices. Using this tool may help in detecting noisy areas and allow you to decide on which channels you may want to use.

The above charts show the traffic from a Wi-Fi network and it can be seen to be operating over channels 6 to 9 and it would be best (though not essential) to avoid using these channels.

## Data Provider Monitor

Data Tag	Total	Per sec	LQI	Value
C629	18	3	100	0.0160147
C623	58	10	100	0.0129487
C628	18	3	100	0.0218671
C62C	18	3	100	0.0152698
C627	17	3	100	0.0172869
C624	17	3	100	0.0130830

Select the devices you wish to log from the above list by checking them. Pressing the Start Logging button will allow you to select a filename to log the data to.

[View Last Log](#) [Start Logging](#)

Connected to Base Station ID FFC5DB App:1.0.0 | Drv COM:1.0.0 | Drv DLL:1.9.0

### Help

This page allows you to monitor Data Provider packets. Data Provider packets are what acquisition devices transmit periodically.

You have the option of logging these to a comma separated value (CSV) file.

T24 acquisition devices normally operate in low power mode and periodically transmit Data Provider packets. This page shows all detected Data Provider packets which may be useful for checking that a device is operational.

**NOTE:** When the toolkit connects to a device to enable configuration it will usually inhibit the transmission of Data Provider packets.

The Start Logging button will ask for a filename and proceed to log the received data to a CSV file in the following format:

**Data Tag, Elapsed mS, Value**

The View Last Log button will launch the application associated with CSV files and open the last logged file.

## Information

**T24 Toolkit**

### Information

WTS-BS-1 Telemetry Display

ID: FFA4DD  
Model: WTS-BS-1  
Firmware Version: 1.02  
Radio Module Firmware Version: 2.1  
Name:

#### Help

Here you can view information about the device. You can also allocate a descriptive name to aid future identification.

Pressing F1 or double-clicking the module image will display the WTS-BS-1 manual if it can be located.

Connected to WTS-BS-1 of ID FFA4DD on channel 1

App: 1.2.25 | Drv COM: 1.7 | Drv DLL: 2.6

Once successfully paired to a device this page is displayed.  
This page shows you information about the connected device.

#### Items you can change:

Name                      You can enter a short description which may help you recognize this device in the future.

## Display Format

Here you can adjust the display.

### Items you can change:

Format & Resolution	Here you can define how the values are displayed on the LCD. There are 7 digits available and you can define where the decimal point is shown by entering text where a zero indicates a numeric digit position. When the data is being displayed the number of decimal places you define may be overridden as the display will always show the correct number of integer digits. Example: If you set the format to 000.0000 and the value to display is 1000.1234 the display will show 1000.123 You can also define the resolution, which is the block size of changes to the display. Example: If you enter the format as 000.0005 the display will only change in steps of 0.0005 which can be used to mask noisy digits at high resolutions.
Leading Zero Suppression	This can be turned on or off and will suppress leading zeroes when on. Example: If the display reads 000.123 with leading zero suppression turned off it will display 0.123 when turned on.
Overload Limit	You can enter a limit here above which <b>Overload</b> will be shown on the display instead of the actual value. Enter zero to disable this feature.
Timeout	Enter the timeout in seconds. This sets the time allowed without any data arriving from the viewed module before all dashes are displayed on the LCD. Should be at least 3 times the interval between the data being transmitted by the acquisition module.
Advanced	This opens the advanced page where you can scale the displayed data.

## Display Format Advanced Settings

**T24 Toolkit**  
**Display Format Advanced**

**Display Update Rate**  
300 You can modify the update rate of the display in milliseconds. The default is 300 for approximately 3 updates per second.

**Custom Display Scaling**

At Low Input Value of 0.0 Display Should Read 0.0  
At High Input Value of 1.0 Display Should Read 1.0

To display the input value without scaling [Click Here](#)

To configure custom display scaling just enter a low and high pair of number indicating what you would like displayed at what received value.

**Input Reading** 0.0 **Displayed Reading** 0.00001  
Shows the input value along with the scaled displayed value.

[Back](#)

Help  
This page allows you to scale the displayed data and to alter the update rate of the LCD display.

Connected to WTS-B5-1 of ID FFA4DD on channel 1 App: 1.2.25 | Drv COM: 1.7 | Drv DLL: 2.6

Here you can adjust the display update rate and also scale the displayed data. This may be used, for example, to convert the data from a WTS-AM-1 calibrated in Kgs so that the handheld display shows Lbs.

### Items you can change:

#### Display Update Rate

Enter the interval in milliseconds between display updates. The default is 300 milliseconds. i.e. 3 updates per second.

#### Custom Display Scaling

This can be used to change the displayed value to a different unit or to otherwise scale it. You simply enter the original and required values at a low and high point.

Example: If a WTS-AM-1 was supplying data in lbf and you wanted to show klbf. You would keep both the low points at zero. Enter **At High Input Value** of 1000 and **Display Should Read Value** of 1.



## Channel and Encryption



Here you can change the channel and encryption key for the acquisition module. If you want to change the channel of an acquisition module and WTS-BS-1 pair there is no need to change both devices.

Simply pair to the handheld and change its channel and key.

Now perform pairing to the acquisition module from the handheld and the acquisition module will be configured to match the handheld.

NOTE: Early acquisition modules do not yet utilize the encryption keys so these should be left at all zeros.

### Items you can change:

- |                |   |
|----------------|---|
| Channel        | Select a channel between 1 and 16. The default is channel 1. You can use the Spectrum Analyzer mode to determine a good clean channel to use.<br>NOTE: Channel 16 is used to negotiate pairing so avoid this channel if possible. |
| Encryption Key | Only devices with identical encryption keys can communicate. You can isolate groups of devices on the same channel or just use the key to ensure the data cannot be read by somebody else.  |



## Save and Restore

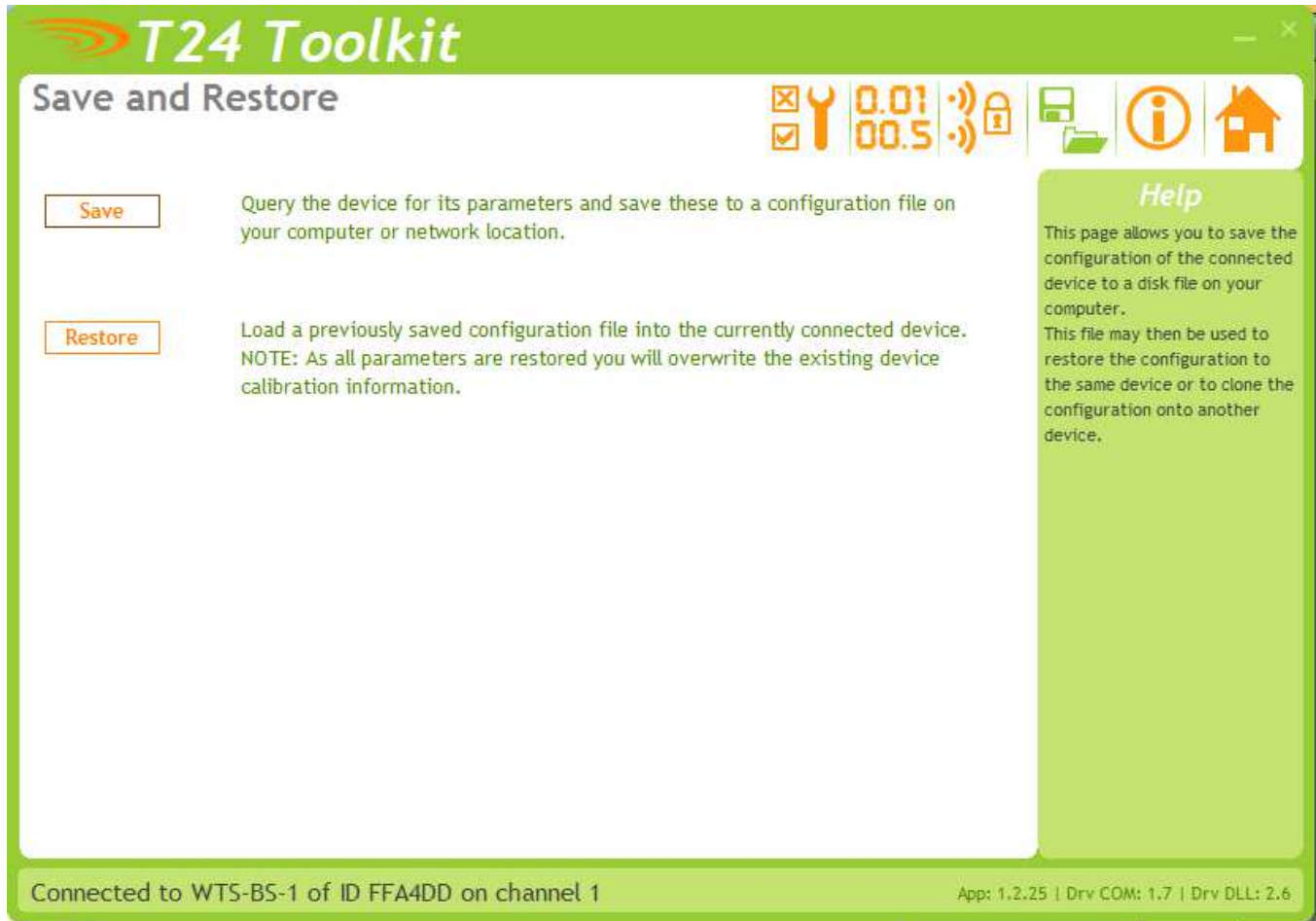

Here you can save the device settings to a file on your PC so that they can be later loaded back into the same or different device.

### Items you can change:

- |                   |   |
|-------------------|---|
| Save              | Click this button to open a file dialog window to allow you to select a filename and location to save the configuration file to. All configuration information including calibration data will be saved to the file. The file extension is <b>tcf</b> .                             |
| Restore           | Click this button to open a file dialog window to allow you to select a filename and location of a previously saved file to load into the connected device. All configuration information <b>including</b> calibration data will be overwritten. The file extension is <b>tcf</b> . |
| Advanced Settings | Click this button to enter the Advanced Settings Page. Here are settings which do not normally require changing.  |

## Advanced Settings

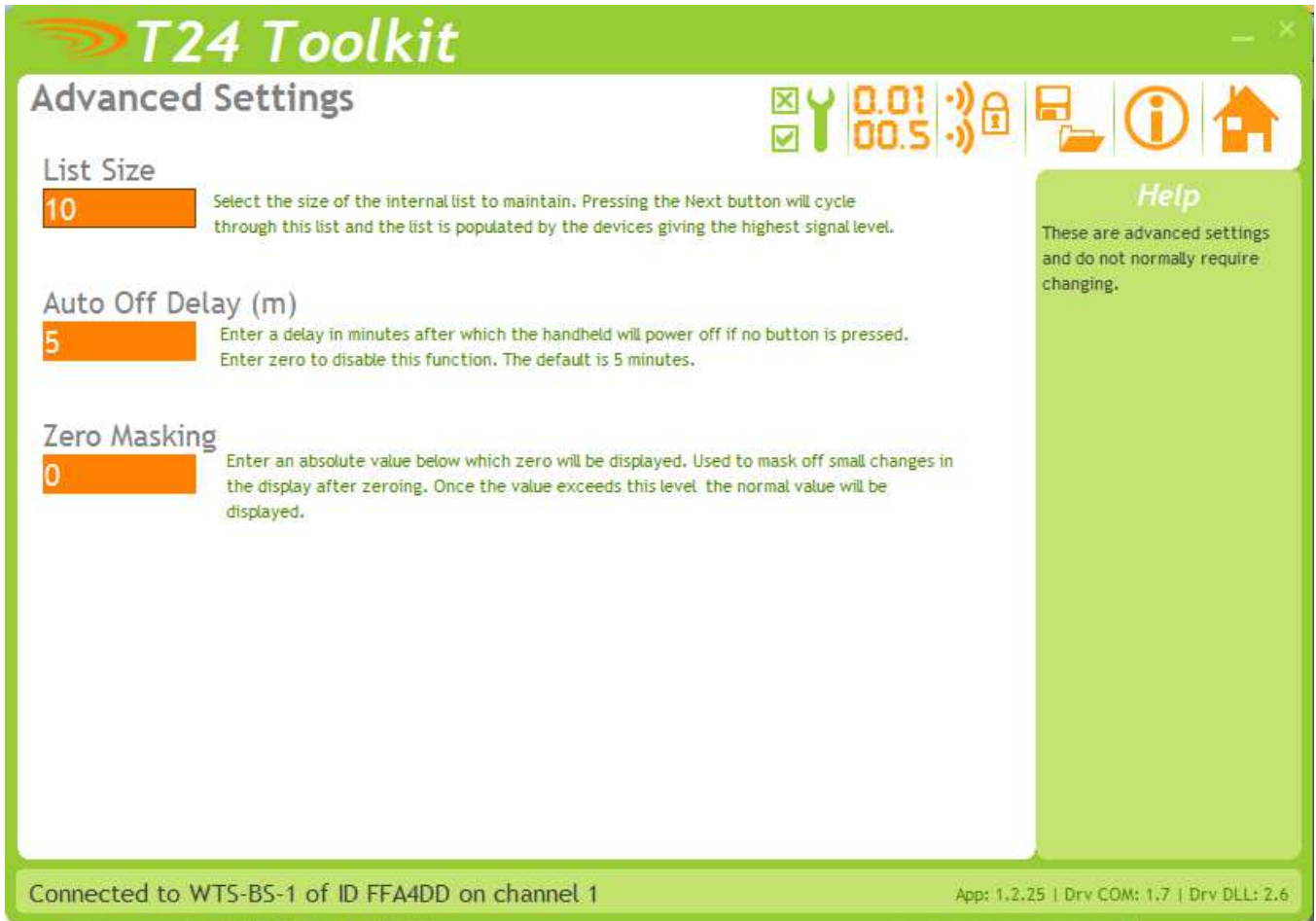

You should not normally need to change these settings.

### Items you can change:

#### List Size

This setting determines how many of the acquisition modules with the highest signal level make up the list which the next key cycles around.

Based on the application and how many acquisition modules are in the vicinity of the handheld this list size can affect how the operator uses the handheld.

See Example Scenarios in the Installation section next. Range is between 1 and 20.

#### Pair Wait Duration

Here you can set the duration that the handheld will wait to achieve successful pairing when pair mode is activated. The default is 5 seconds.

#### Auto Off Delay

Here you can specify the delay in minutes after which the handheld will automatically turn off after no button is pressed.

Enter zero to disable this function. The default is 5 minutes.

The On/Off key can be used to reset this by giving a quick press. This may be more suitable than using the Next key!

#### Zero Masking

Enter a value in engineering units which represents a band (+/-) about zero within which zero will be displayed. As soon as the value is outside this band the real value will be shown. (Only available in version 1.01 onwards)

## Installation

### Example Scenarios

The following example scenarios explain the usage of the handheld and acquisition modules and lists the important settings chosen to achieve this.

#### Scenario 1 - 200 acquisition modules are spaced at intervals of a few feet along a bridge.

The modules spend most of their time in deep sleep and are only activated when the operator uses the handheld.

The acquisition modules are set for a transmission interval of 333 milliseconds (3Hz) and have a sleep delay of 5 seconds.

On the WTS-BS-1 setting the List Size to 6 allows the operator a fast responding Next key that cycles through the closest 6 modules to allow the operator to note any out of limit readings. The operator checks the Data Tag displayed on the handheld as the Next key is pressed against the Data Tag painted on the modules affixed to the bridge.

The operator walks the length of the bridge and stops approximately every 20 feet and quickly scrolls through the small list size and records the readings of the 6 local modules.

The list dynamically repopulates as he walks along the length of the bridge.

During the walk modules are automatically woken by the handheld as they enter range and as the operator walks out of range the modules automatically return to sleep.

#### Scenario 2 - The operator has 3 rooms to monitor.

Each room contains 10 acquisition modules. These modules are always fully awake but operate at a transmission interval of 10 seconds. There is another device that is logging the data from these modules so their sleep delay is set to zero to disable that function.

By setting the List Size to 10 the operator can enter the desired room and simply cycle through the 10 modules present in that room.

Because the acquisition modules only transmit at 10 second intervals it can take up to 10 seconds for a particular module to be available from the handheld. The timeout on the handheld is set to 31 seconds.

The input to the acquisition modules is very slow to change so although the displayed value only updates every 10 seconds the operator is still seeing a valid reading as he cycles through the acquisition modules. The timeout of 31 seconds allows for the odd dropped reading but if a module dropped out permanently for whatever reason the handheld would display ----- after 31 seconds or the module would never appear in the list if it had not transmitted since the handheld had been turned on.

#### Scenario 3 - 500 pallets are stored in a warehouse.

Each pallet has an acquisition module built in that transmits the weight on the pallet. The modules have been configured so that the LED state is echoed onto the digital output and this is used to power a high brightness blue LED attached to the front of the pallet. The module transmission intervals are set to 3 per second and a sleep delay of 10 seconds. The LED flashes at 3Hz while the module is awake and is off when asleep. When the handheld is displaying the reading from the module its LED is on constantly.

On the handheld the List Size is set to 1. This has the effect of allowing the operator to approach the desired pallet and press the Next key. This will effectively select the module with the highest radio signal which will be the one the operator is standing next to and the LED will light to provide visual feedback so the operator knows he is looking at the correct pallet.

The operator moves to the next pallet and presses the Next key again at which point the previous pallet LED goes off and the closest pallet LED activates.

As the operator moves out of range pallets go back to sleep because of their sleep delay settings.

## Overview

Radio performance at microwave wavelengths is very dependent upon the operating environment; any structure within the operating region of the radios will give rise to three effects:

**Obscuration:** Obscuration will result in reduced range and occurs when an obstruction masks the line-of-sight between radios.

**Aberrations to the horizontal and vertical space patterns.** Distortion of these patterns may occur if structures or objects are placed in the near or intermediate field of the antenna. The effect will be to distort the coverage patterns, adversely affecting range and link quality.

**Reflection:** Any object placed in line-of-sight of the transmit antenna will result in signals arriving at the receiver by an indirect path. Degradation of performance due to reflection (multipath effects) appears as reduced range or poor link quality.

Any of the above will cause poor RSSI figures, an increase in the packet loss rate and in extreme cases complete loss of signal. Fortunately, if consideration is given to these effects at the integration stage then a good quality link will be obtained.

### Guidelines for product design:

When selecting materials for product enclosures, preference should be given to fiberglass, light colored ABS or Polypropylene; at the wavelength of 2.4GHz radio other materials will adversely affect the signal by attenuation, refraction or change in polarization.

If the application demands that the radio is installed inside a metal enclosure then ensure that the specified clearances are maintained around the antenna and design in a fiberglass RF window at least as large as the clearance dimensions but ideally as large as possible.

RAD24i radios installed inside a product should be oriented so that the chip antenna will be vertical when the product is in its normal operating position.

### Guidelines for installation:

When planning installations ensure that line-of-sight between nodes is maintained and that objects or structures are kept at least one meter away from antennae wherever possible.

To avoid poor link quality between a RAD24i radio and a handheld device ensure that the RAD24i is mounted so that the chip antenna is vertical. Improvement may also be obtained by altering the height above ground of the RAD24i; a small increase or reduction in antenna elevation will often improve reception.

Range underwater is only 4 inches (0.1M) or so depending on packet rate. Best performance underwater is obtained by using low packet rates and immersing water-proofed antennae rather than water-tight enclosures containing the antennae.

## Antenna Orientation

For the maximum range the acquisition module and the WTS-BS-1 should be orientated as shown. The sensitivity to the radio transmission will be reduced if the acquisition module is oriented in a vertical or portrait position.

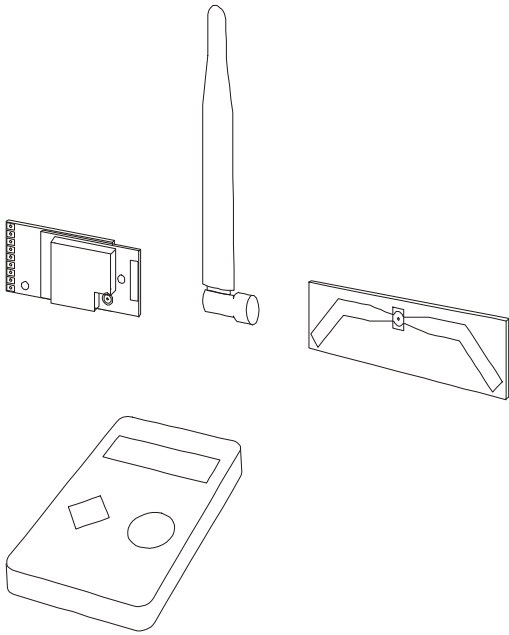

## Battery

Use a pair of alkaline AA batteries. Due to the higher voltage requirements of this device NiMh and NiCad batteries are not recommended.

## Specifications

### General Radio

	Min	Typical	Max	Units
License		License Exempt		
Modulation method		MS (QPSK)		
Radio type		Transceiver (2 way)		
Data rate		250		K bits/sec
Radio Frequency	2.4000		2.4835	GHz
Power		1		mw
Range			200 (650)	Meters (feet) *
Channels (DSSS)		16		

\* Maximum range achieved in open field site at a height of 3 meters above ground.

### WTS-BS-1

Electrical	Min	Typical	Max	Units
Power Supply voltage	2.5	3.0	3.6	V DC

Power Supply	Min	Typical	Max	Units
Active		35	40	mA
Low power mode		120	160	uA
Estimated Battery life using 2Ahr batteries:				
Standby mode (Powered off)		1.5		Years
Continuous operation		40		Hours

Environmental	Min	Typical	Max	Units
IP rating		IP65		
Operating temperature range	-10		+50	C
Storage temperature	-40		+85	C
Humidity	0		95	%RH

Physical	
Hand Held Dimensions	90 x 152 x 34mm

## Approvals

CE



Complies with EMC directive. 2004/108/EC  
The Radio Equipment and Telecommunications Terminal Equipment (R&TTE) Directive,  
1999/5/EC,

### European Community, Switzerland, Norway, Iceland, and Liechtenstein

- English: This equipment is in compliance with the essential requirements and other relevant provisions of Directive 1999/5/EC.
- Deutsch: Dieses Gerät entspricht den grundlegenden Anforderungen und den weiteren entsprechenden Vorgaben der Richtlinie 1999/5/EU.
- Dansk: Dette udstyr er i overensstemmelse med de væsentlige krav og andre relevante bestemmelser i Direktiv 1999/5/EF.
- Español: Este equipo cumple con los requisitos esenciales así como con otras



disposiciones de la Directive 1999/5/EC.

Français: Cet appareil est conforme aux exigences essentielles et aux autres dispositions pertinentes de la Directive 1999/5/EC.

Íslenska: Þessi búnaður samrýmist lögboðnum kröfum og öðrum ákvæðum tilskipunar 1999/5/ESB.

Italiano: Questo apparato é conforme ai requisiti essenziali ed agli altri principi sanciti dalla Direttiva 1999/5/EC.

Nederlands: Deze apparatuur voldoet aan de belangrijkste eisen en andere voorzieningen van richtlijn 1999/5/EC.

Norsk: Dette utstyret er i samsvar med de grunnleggende krav og andre relevante bestemmelser i EU-direktiv 1999/5/EC.

Português: Este equipamento satisfaz os requisitos essenciais e outras provisões da Directiva 1999/5/EC.

Suomalainen: Tämä laite täyttää direktiivin 1999/5/EY oleelliset vaatimukset ja on siinä asetettujen muidenkin ehtojen mukainen.

Svenska: Denna utrustning är i överensstämmelse med de väsentliga kraven och andra relevanta bestämmelser i Direktiv 1999/5/EC.

This equipment is in compliance with the essential requirements and other relevant provisions of Directive 1999/5/EC.

## FCC



Family: RAD24

FCC ID:VHARAD24

This device complies with Part 15c of the FCC Rules. Operation is subject to the following two conditions: (1) this device may not cause harmful interference, and (2) this device must accept any interference received, including interference that may cause undesired operation.

**CAUTION:** If the device is changed or modified without permission from Interface Inc, the user may void his or her authority to operate the equipment.

## Industry Canada



Industry Industrie  
Canada Canada

IC:7224A-RAD24

This apparatus complies with RSS-210 - Low-power License-exempt Radiocommunication Devices (All Frequency Bands): Category I Equipment RSS.

## OEM / Reseller Marking and Documentation Requirements

### FCC

The Original Equipment Manufacturer (OEM) must ensure that FCC labeling requirements are met. This includes a clearly visible label on the outside of the final product enclosure that displays the contents as shown:

Contains FCC ID:VHARAD24

This device complies with Part 15 of the FCC Rules. Operation is subject to the following two conditions:

(1) this device may not cause harmful interference and

(2) this device must accept any interference received, including interference that may cause undesired operation.

The acquisition modules have been tested with only certain antennas. When integrated in OEM products, fixed antennas require installation preventing end-users from replacing them with non-approved antennas. Antennas other than previously tested types must be tested to comply with FCC Section 15.203 (unique antenna connectors) and Section 15.247 (emissions).

Acquisition modules have been certified by the FCC for use with other products without any further certification (as per FCC section 2.1091). Changes or modifications not expressly approved by Interface could void the user’s authority to operate the equipment.

In order to fulfill the certification requirements, the OEM must comply with FCC regulations:

1. The system integrator must ensure that the text on the external label provided with this device is placed on the outside of the final product.
2. The acquisition modules with external antennas may be used only with Approved Antennas that have been tested by Interface.

## IC

Labeling requirements for Industry Canada are similar to those of the FCC. A clearly visible label on the outside of the final product enclosure must display the following text:

Contains Model RAD24 Radio (2.4 GHz), IC:7224A-RAD24

Integrator is responsible for its product to comply with RSS-210 - Low-power License-exempt Radiocommunication Devices (All Frequency Bands): Category I Equipment RSS.

## CE

The WTS series has been certified for several European countries.

If the acquisition module is incorporated into a product, the manufacturer must ensure compliance of the final product to the European harmonized EMC and low-voltage/safety standards. A Declaration of Conformity must be issued for each of these standards and kept on file as described in Annex II of the R&TTE Directive. Furthermore, the manufacturer must maintain a copy of the WTS device user manual documentation and ensure the final product does not exceed the specified power ratings, antenna specifications, and/or installation requirements as specified in the user manual. If any of these specifications are exceeded in the final product, a submission must be made to a notified body for compliance testing to all required standards.

### OEM Labeling Requirements

The ‘CE’ marking must be affixed to a visible location on the OEM product.



The CE mark shall consist of the initials “CE” taking the following form:

- If the CE marking is reduced or enlarged, the proportions given in the above graduated drawing must be respected.
- The CE marking must have a height of at least 5mm except where this is not possible on account of the nature of the apparatus.
- The CE marking must be affixed visibly, legibly, and indelibly.

## Worldwide Regional Approvals

Region	Product Conforms To
Europe	CE
USA	FCC
Canada	IC
Australia	To Be Determined
China	To Be Determined
Japan	To Be Determined

### Important Note

Interface does not list the entire set of standards that must be met for each country. Interface customers assume full responsibility for learning and meeting the required guidelines for each country in their distribution market. For more information relating to European compliance of an OEM product incorporating the WTS range of modules, contact Interface.

## Warranty

All Telemetry products from Interface Inc., ('Interface') are warranted against defective material and workmanship for a period of (1) one year from the date of dispatch.

If the 'Interface' product you purchase appears to have a defect in material or workmanship or fails during normal use within the period, please contact your Distributor, who will assist you in resolving the problem. If it is necessary to return the product to 'Interface' please include a note stating name, company, address, phone number and a detailed description of the problem. Also, please indicate if it is a warranty repair.

The sender is responsible for shipping charges, freight insurance and proper packaging to prevent breakage in transit.

'Interface' warranty does not apply to defects resulting from action of the buyer such as mishandling, improper interfacing, operation outside of design limits, improper repair or unauthorised modification.

No other warranties are expressed or implied. 'Interface' specifically disclaims any implied warranties of merchantability or fitness for a specific purpose. The remedies outlined above are the buyer's only remedies. 'Interface' will not be liable for direct, indirect, special, incidental or consequential damages whether based on the contract, tort or other legal theory.

Any corrective maintenance required after the warranty period should be performed by 'Interface' approved personnel only.

In the interests of continued product development, Interface Inc. reserves the right to alter product specifications without prior notice.